



Consorzio di bonifica
Dugali Naviglio Adda Serio

**PIANO COMPENSORIALE DI BONIFICA, DI IRRIGAZIONE
E DI TUTELA DEL TERRITORIO RURALE**

L.R. 5 dicembre 2008 n. 31, art. 88 - D.G.R. 2 ottobre 2015 n. X/4110



TAVOLA	TITOLO		GRUPPO DI LAVORO		
SCALA	APPENDICE D-2: QUADRI SINOTTICI DI BONIFICA - NAVIGLIO		ing. Paolo Micheletti geom. Paolo Antonioli ing. Stefano Antonioli ing. Chiara Bonapace dott. Chiara Francia ing. Stefano Valdameri		
DATA ELABORATO			i4 Consulting S.r.l. Via Barrocchio dal Borgo, 1 35124 Padova (PD) tel. 049 7966665 - fax 049 685800 info@i4consulting.it - www.i4consulting.it		
Giugno 2018			dott. Pietro Fanton ing. Alvisè Fiume ing. Mauro Tortorelli ing. Elisa Alessi Celegon ing. Elia De Marchi ing. Silvia Garbin ing. Gianluca Lazzaro		
 Via Ponchielli 5, 26100 Cremona (CR) tel. 0372 25315 www.dunas.it- info@dunas.it		dott. Stefania Anghinelli pian.re terr.le Sara Lodrini		 UNIVERSITÀ DEGLI STUDI DI PADOVA Centro di Idrologia "DINO TONINI" Via Loredan, 20 35131 Padova tel. 0498275442 - fax 0498275446	
COMMESSA N.					
SO178/2016					
1	06/2018	Aggiornato secondo indicazioni Parere Motivato			
0	03/2018	Prima emissione			
REV. N°	DATA	MOTIVO DELLA REVISIONE		VERIFICATO	APPROVATO

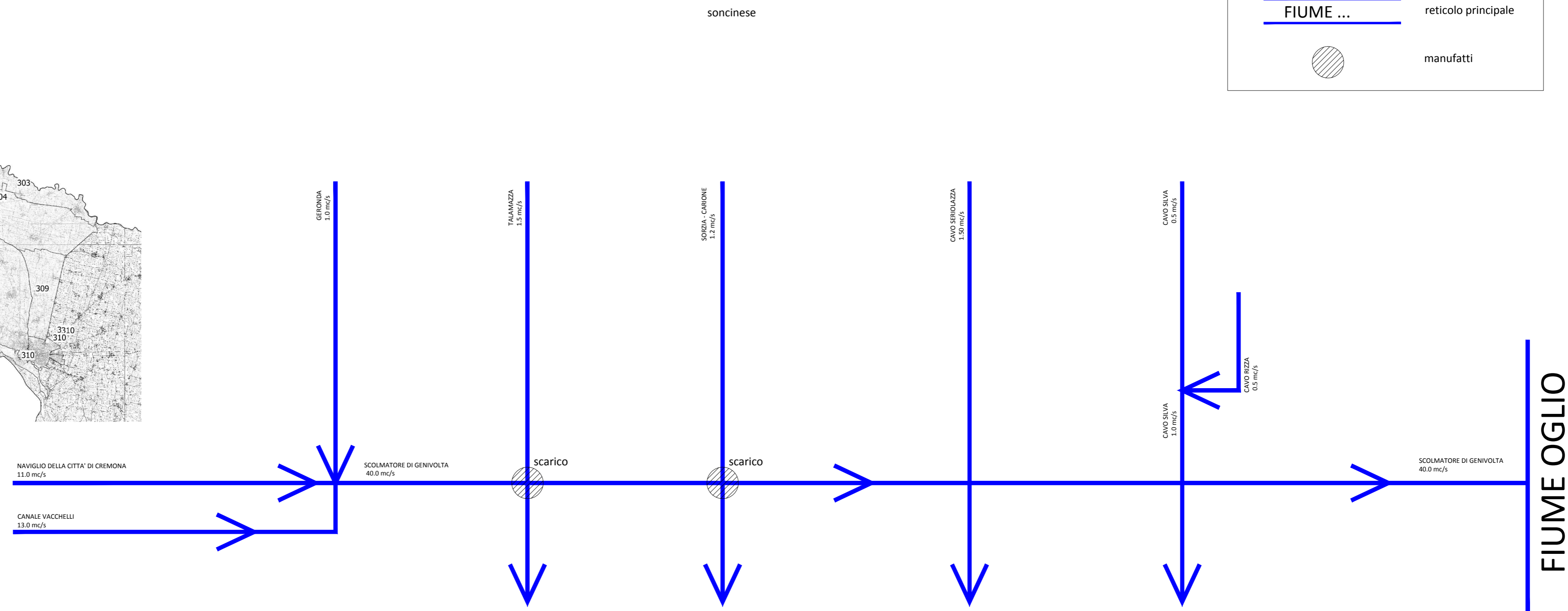
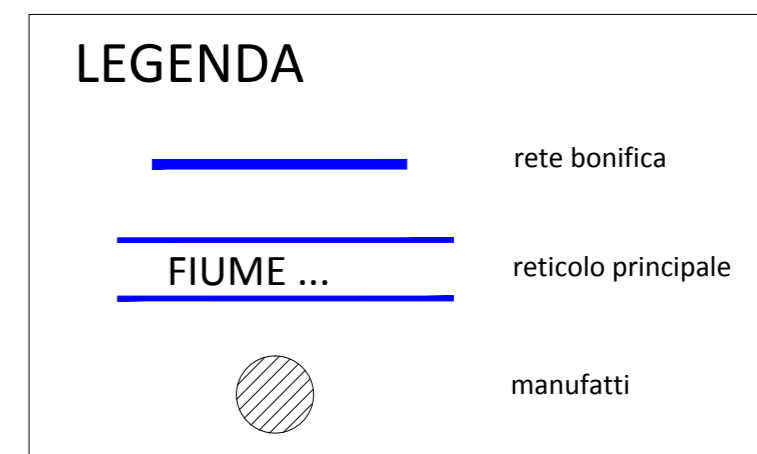
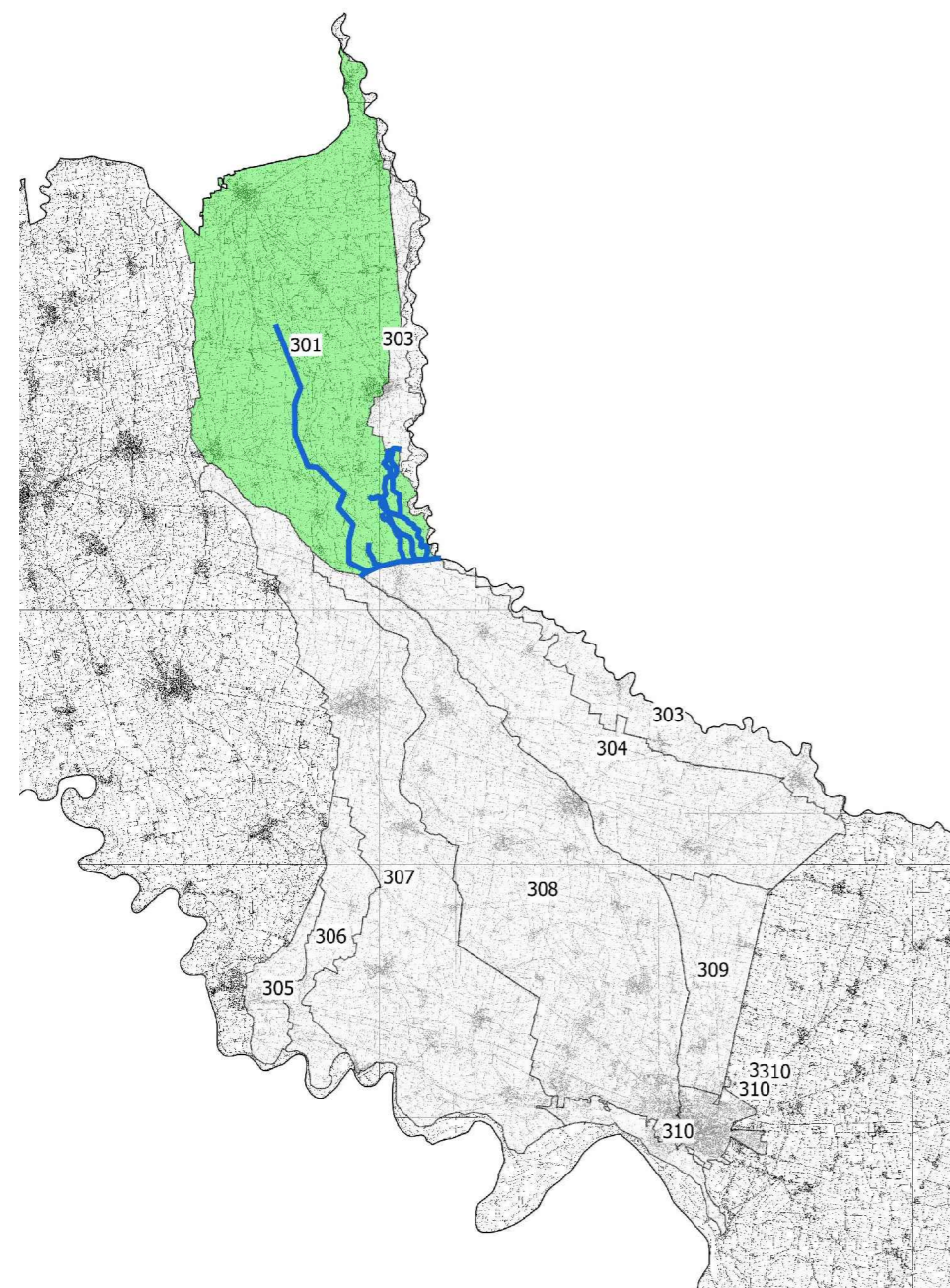

Consorzio di bonifica Dugali - Naviglio - Adda Serio
 DISTRETTO NAVIGLIO - SCHEMA RETE BONIFICA
 BACINO SONCINESE (301)

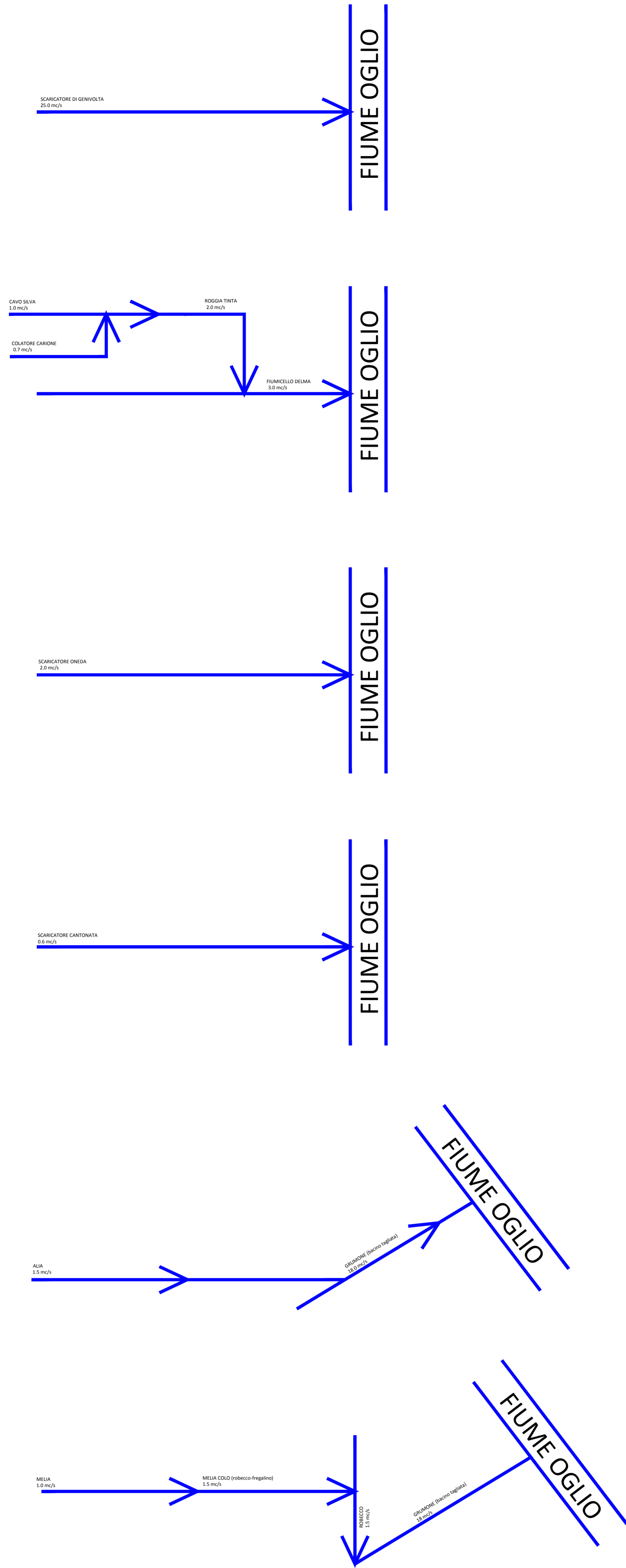

SCHEMA RETE COLANTE BACINO OGLIO (304)

oglio



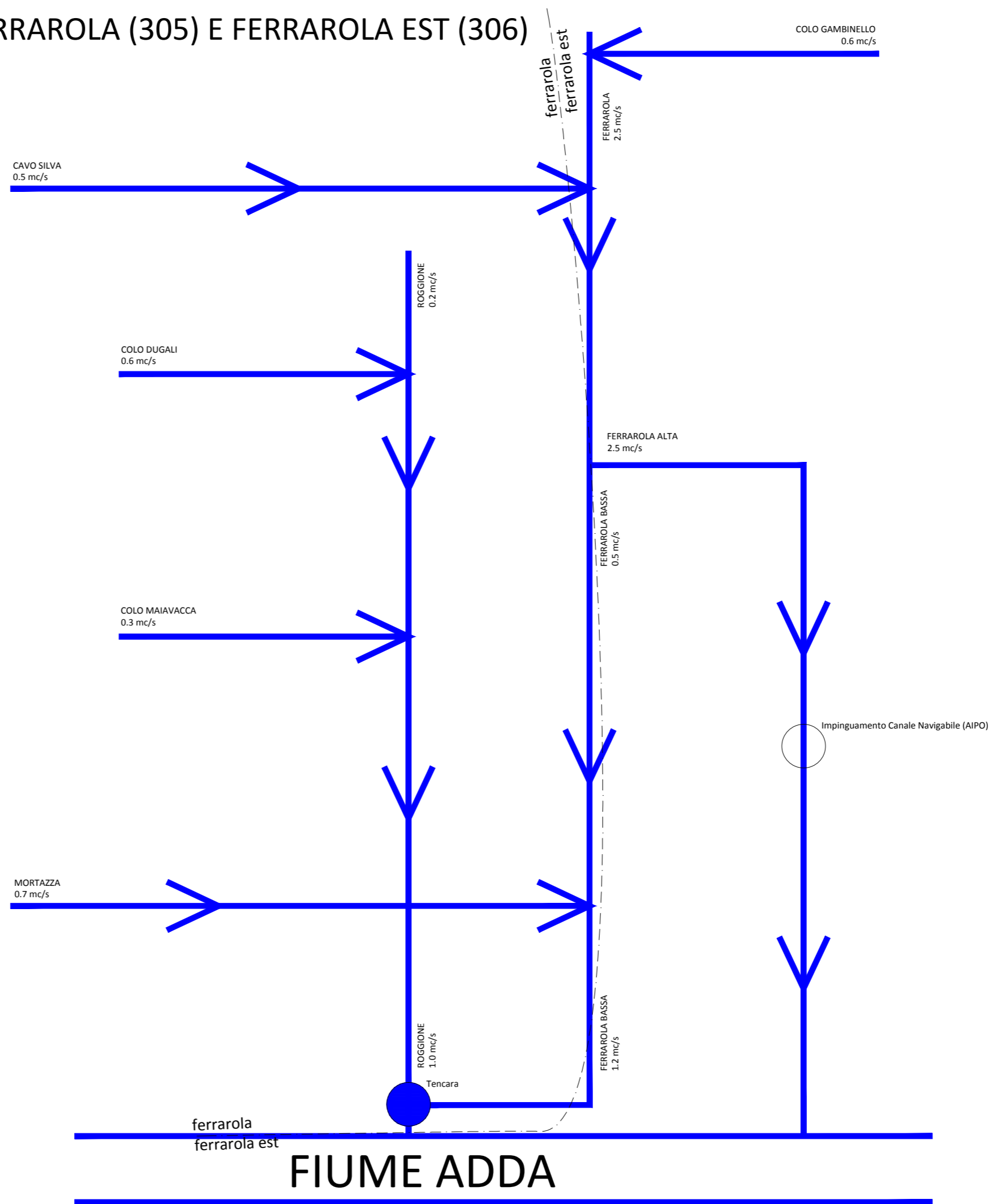

LEGENDA	
	rete bonifica
	reticolo principale

SCHEMA RETE COLANTE BACINI FERRAROLA (305) E FERRAROLA EST (306)

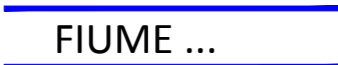

LEGENDA

-  rete bonifica
-  reticolo principale
-  impianto idrovoro
-  limite bacini idraulici

SCHEMA RETE COLANTE BACINO RIGLIO (307)

LEGENDA

- rete bonifica
- rete irrigua
- FIUME ...
reticolo principale

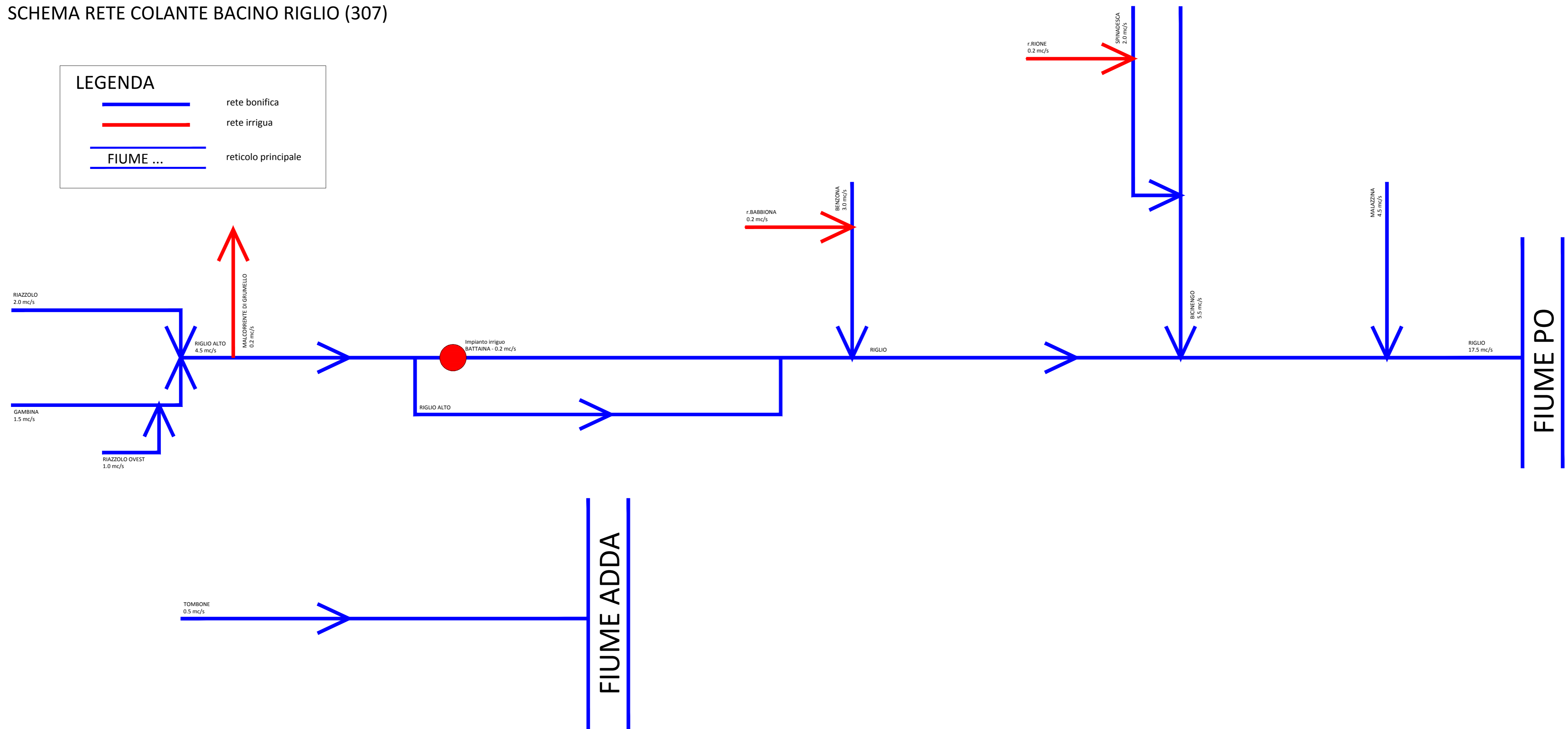

SCHEMA RETE COLANTE BACINO MORBASCO (308)

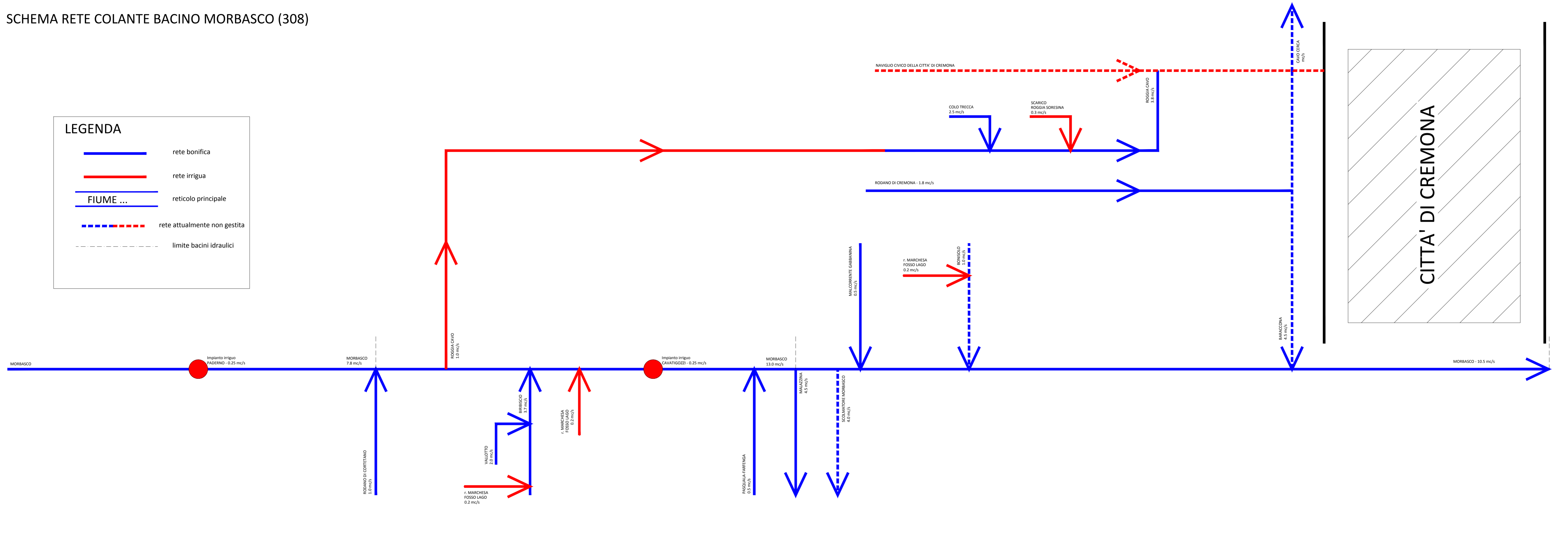

LEGENDA

- rete bonifica
- rete irrigua
- FIUME ... reticolo principale
- rete attualmente non gestita
- limite bacini idraulici

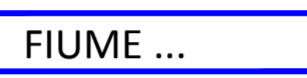

SCHEMA RETE COLANTE BACINO ROBECCO - FREGALINO (309)

LEGENDA

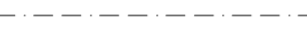
-  rete bonifica
-  reticolo principale
-  rete attualmente non gestita
-  limite bacini idraulici

